

BATLSKIN
caiman[®]

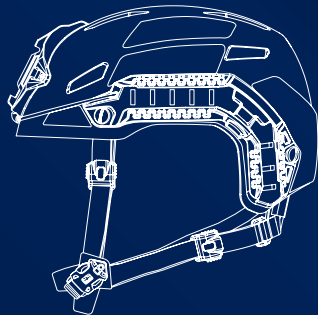
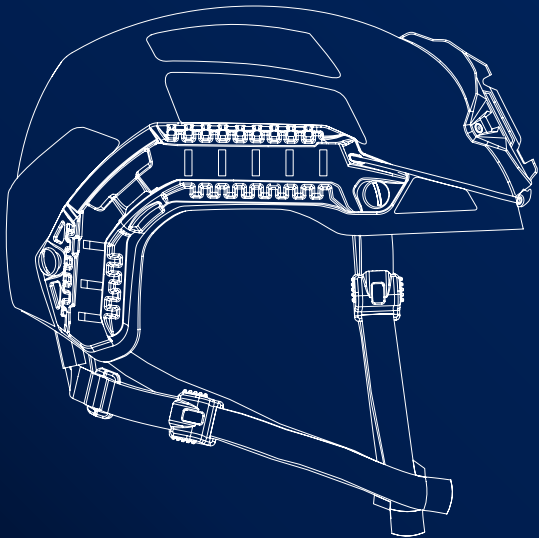

HEAD PROTECTION SYSTEM
INSTRUCTION GUIDE

CAIMAN HEAD PROTECTION SYSTEM

TO THE OPERATOR – No matter the pace, the obstacles, or the environment, your command wants you to have full-spectrum protection for your mission. Caiman Helmet Systems were designed based on intensive direct collaboration with SOF users. The end-result: scalable, lightweight, comfortable system that is purpose-built to integrate with mission-specific headborne equipment. This is cutting-edge head protection for the modern battlefield.

GALVION. EMPOWER YOUR MISSION.

PLEASE BE SURE TO READ ALL INSTRUCTIONS AND FOLLOW ALL WARNINGS. POOR SET-UP AND ADJUSTMENT MAY COMPROMISE THE SYSTEMS ABILITY TO PROVIDE THE PROTECTION THAT IT IS DESIGNED TO DELIVER DURING A BLUNT FORCE OR BALLISTIC IMPACT.



**FOR MOST
UP TO DATE
PRODUCT
INFORMATION
SCAN HERE.**

HAVE QUESTIONS OR COMMENTS? CONTACT GALVION CUSTOMER SUPPORT

1-866-713-0406 | CUSTOMERCARE@GALVION.COM | GALVION.COM

CONTENTS

This manual provides information regarding the components of your Batlskin Caiman Head Protection System. This helmet was developed to provide the best blunt force and ballistic protection in a scalable, lightweight package that is fully modular and fully integrated.

HELMET ANATOMY		FIT & CUSTOMIZATION		ACCESSORY COMPATIBILITY	
Caiman Helmet	4	Sizing	7	Rail Adapters	14
APEX Liner	5	How to measure head size	7	Helmet Cover	15
Rails	6	Helmet	8	Headset Integration (Band)	16
		Adjusting Retention System	9	Headset Integration (Rail)	17
		Installing Integrated		Fixed Arm Visor	18
		Nape Pad Cover	11	Mandible Guard	19
		Adjusting Fitband System	12	Spare Parts	20
		Adjusting Suspension System	13	Additional Accessories	22
				Care & Support	23

THE IMAGES USED IN THIS GUIDE ARE FOR REFERENCE ONLY AND MAY NOT REFLECT THE EXACT CONFIGURATION OF THE PRODUCT

CAIMAN HELMET

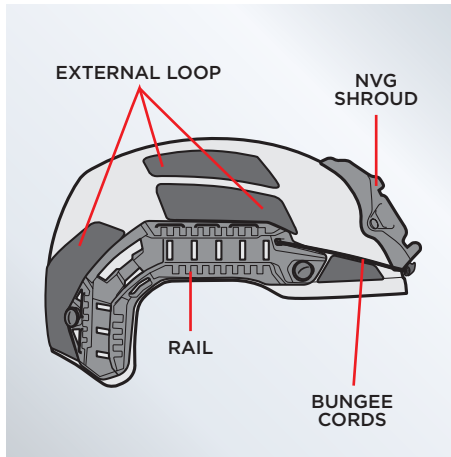

BALLISTIC

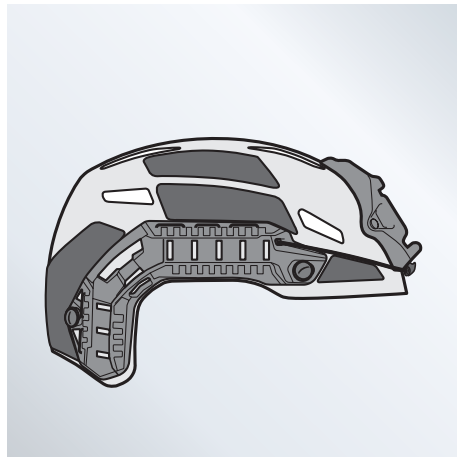

NON-BALLISTIC

APEX LINER

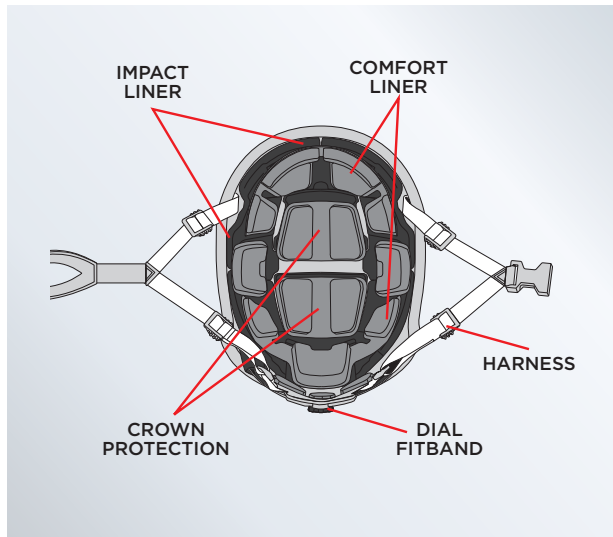

RAILS

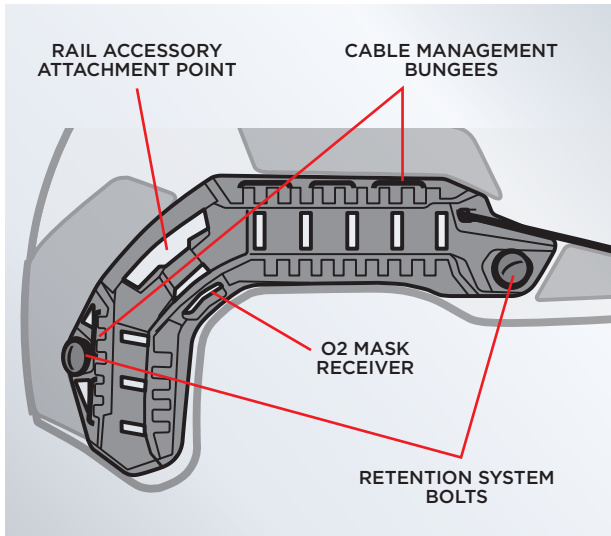

Use cable management bungees to secure power or data cables.

SIZING - HOW TO MEASURE HEAD SIZE

User will obtain the most accurate head measurements using a tape measure for circumference and a caliper for length and width.

Evaluate size while wearing the typical, everyday headwear, hairstyle, head coverings, etc., worn with helmet.

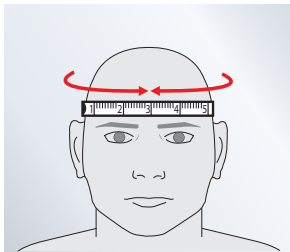

Using a measuring tape at approximately 13mm ($\frac{1}{2}$ ") above eyebrows and ears, measure head **CIRCUMFERENCE**.

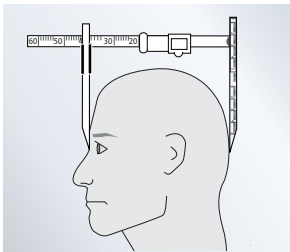

In the absence of a caliper, use 2 pencils. Hold one pencil between eyebrows and one at the back of head. An extra set of hands is important to ensure pencils are straight. Measure distance between pencils - this is the **LENGTH** measurement.

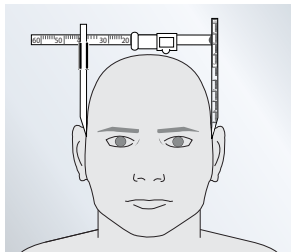

In the absence of a caliper, use 2 pencils. Hold one pencil at either side of head above ears. An extra set of hands is important to ensure pencils are straight. Measure distance between pencils - this is the **WIDTH** measurement.

SIZING - HELMET

- Head circumference is the best predictor of helmet size – start there and refine using length and width measurements as needed.
- Be sure to also evaluate fit with additional equipment (headset, cold weather gear, eye protection, etc.) as these will all affect the amount of space needed in helmet.
- With use, liners get worn in and compressed or stretched, and helmet may feel larger so make sure to have snug fit when trying on with new liner system.

MEASUREMENTS IN mm

	SMALL	MEDIUM	LARGE	X-LARGE	XX-LARGE
CIRCUMFERENCE	525 - 570	545 - 590	570 - 610	590 - 630	610 - 655
LENGTH	up to 205	up to 210	up to 215	up to 220	up to 230
WIDTH	up to 165	up to 175	up to 185	up to 190	up to 195

ADJUSTING RETENTION SYSTEM

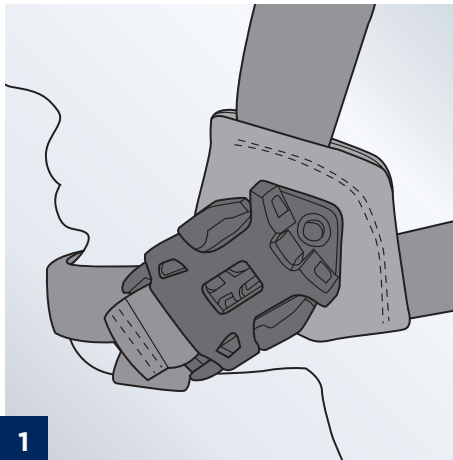

1 Buckle chinstrap.

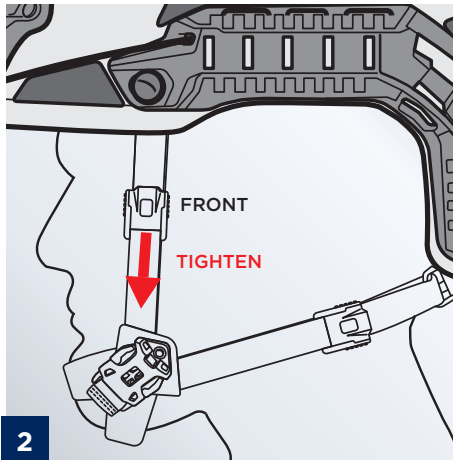

2 Unlock front tensioner and tighten as needed. Lock in place.

Users may find it easier to adjust tensioners on both left and right side of harness at the same time.

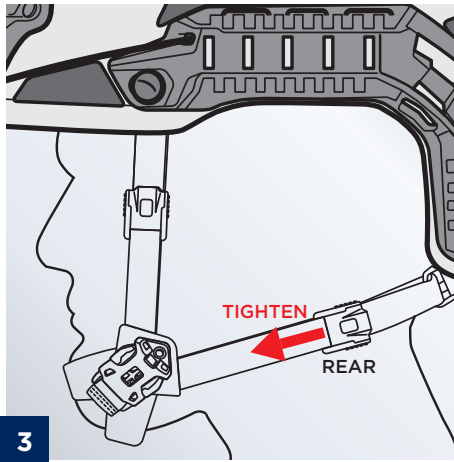

Unlock rear tensioner and tighten as needed. Lock in place.

Users may find it easier to adjust tensioners on both left and right side of harness at the same time.

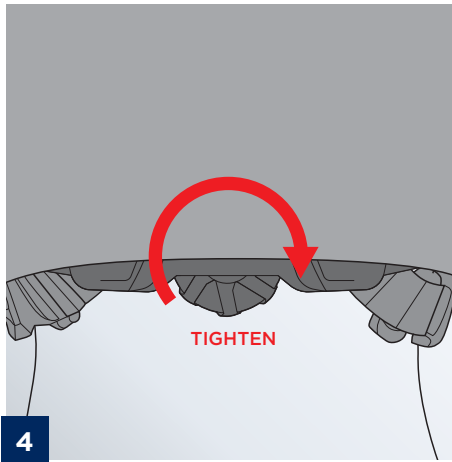

Tighten fitband by turning the dial clockwise.

INSTALLING INTEGRATED NAPE PAD COVER

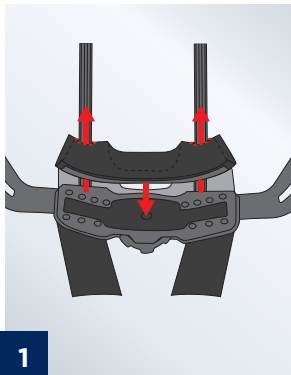
**1**

The fitband cover is attached to the fitband.

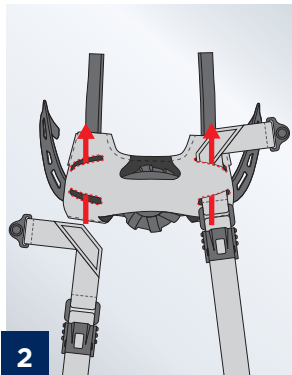
**2**

The harness is fed through and bolted into the helmet.

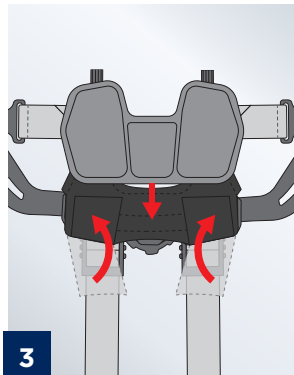
**3**

The nape pad is then added to the assembly.

ADJUSTING FITBAND SYSTEM

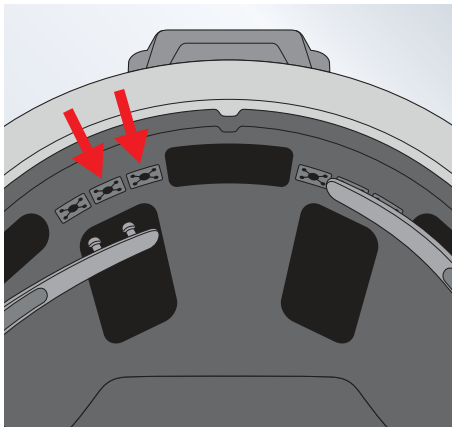

FITBAND TOO LOOSE?

Snap fitband arm posts towards front of helmet for narrower fit.

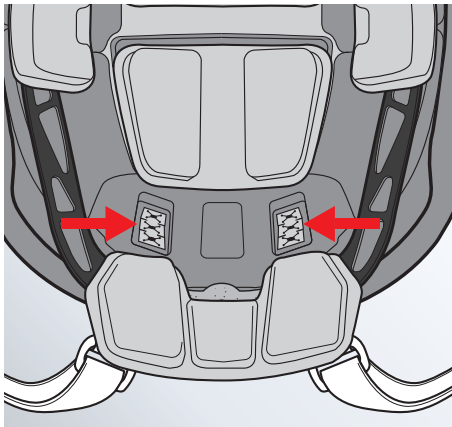

NAPE PAD TOO LOW?

Nape pad should rest at the base of skull. Adjust higher if needed.

Users may prefer a higher nape pad position for increased neck range of motion while in the prone position.

ADJUSTING SUSPENSION SYSTEM

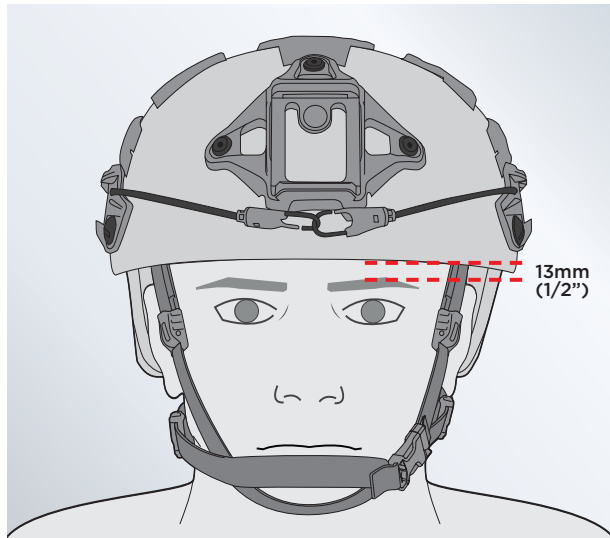

Helmet should sit approximately 13mm (1/2") above brow.

RAIL ADAPTERS

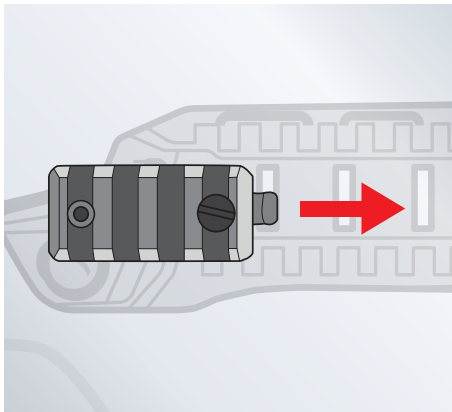

PICATINNY RAIL ADAPTER

Squeeze the end tab and slide the adapter onto rail channel tab-first. Once in the preferred position, release the tab and tighten the screw to secure the adapter in place.

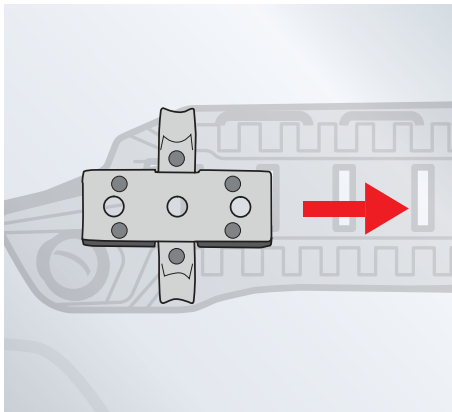

CROSS BASE RAIL ADAPTER

Attach the desired accessory onto the rail adapter. Tighten screws provided with the accessory to secure it in place. Pinch the tabs on either side of the adapter and slide onto rail. Release the tabs when in the preferred position.

HELMET COVER

(Ordered Separately)

HELMET COVER DESIGNS VARY

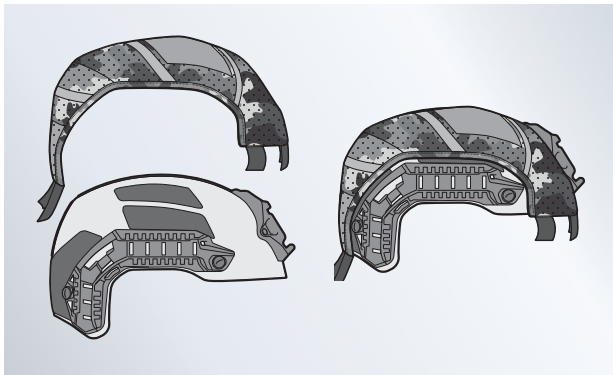

1. Align the front hole in the helmet cover with the mount of the helmet.
2. Pull cover over helmet shell, ensuring seams of cover are symmetrical and there are minimal ripples in the fabric.
3. Pull loop tabs tightly over helmet edge and adhere to hook dots already installed in helmet. The loop tabs should not cover any holes in helmet.

HEADSET INTEGRATION (BAND)

(Ordered Separately)

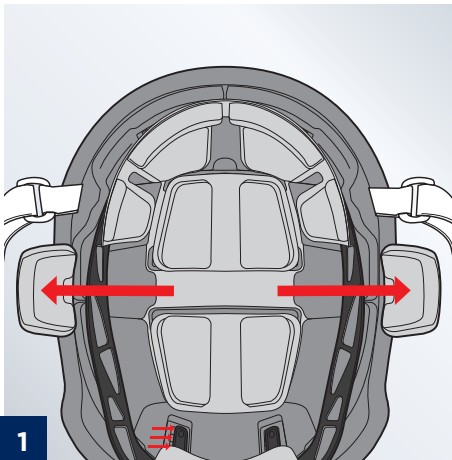

(OPTIONAL) Remove the side comfort pads.

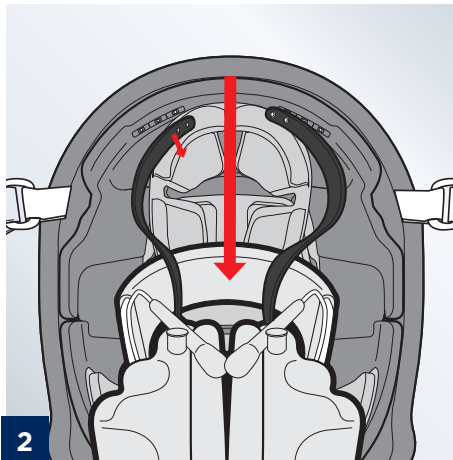

(OPTIONAL) Make helmet and headset a single unit by weaving headset through fitband arms and re-attaching.

HEADSET INTEGRATION (RAIL)

(Ordered Separately)

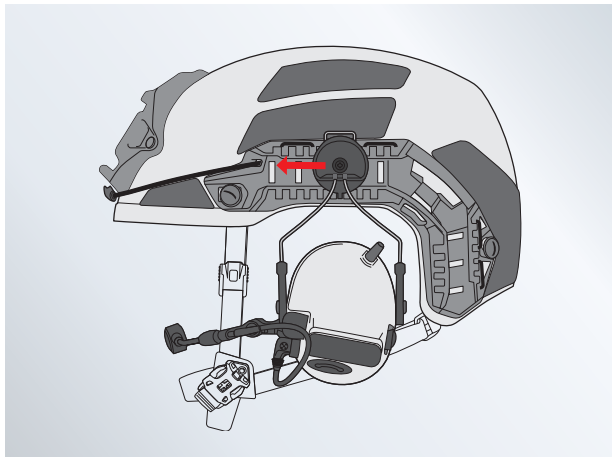

Slide adapter into desired position. Store cup-to-cup wire in helmet cover or inside helmet as desired.

FIXED ARM VISOR

(Ordered Separately)

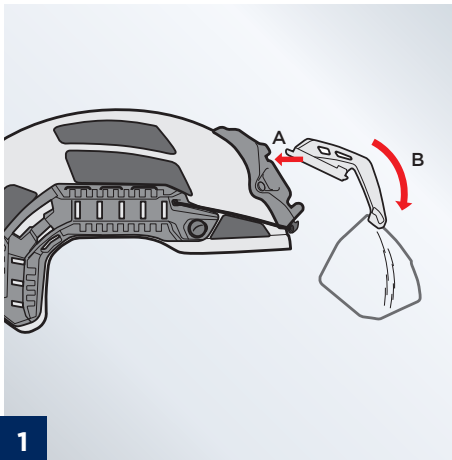

- A.** Insert top edge of visor arm into shroud.
- B.** Tilt visor arm down and lock visor into shroud.

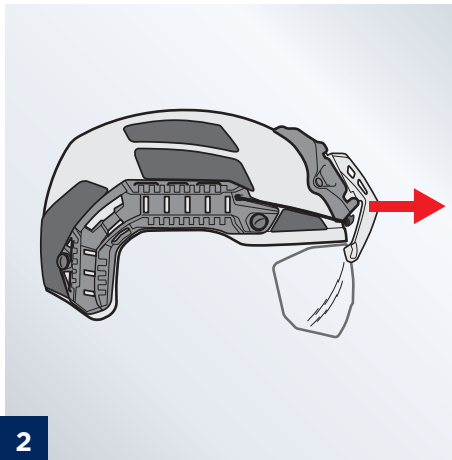

- 2.** Pull on visor arm to ensure it is secured in place – it should not release.

MANDIBLE GUARD

(Ordered Separately)

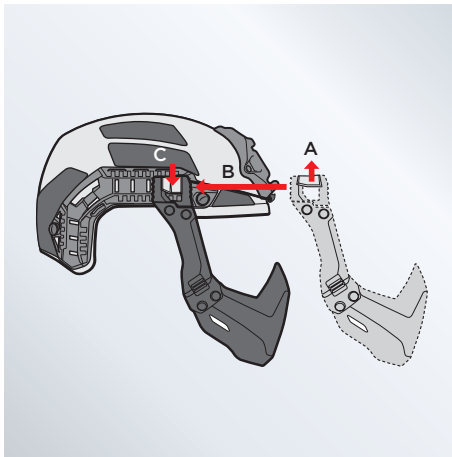

- A.** Open mandible arm latches.
- B.** Insert mandible arms into rail until they stop.
- C.** Lock mandible arm latches.

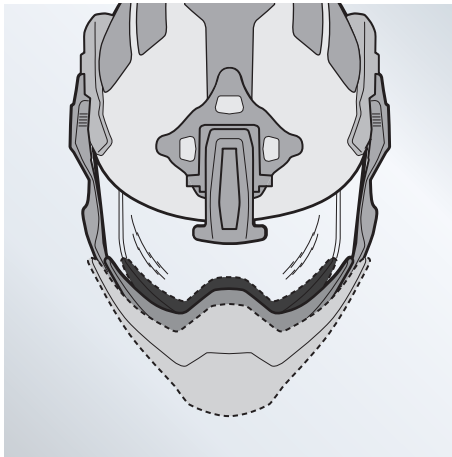

Mandible size is based on face length and does not necessarily correspond with user helmet size.

2 SIZES: SM-MD-LG and XL-XXL.
Both sizes are compatible on **ALL** helmets.

SPARE PARTS

(Ordered Separately)



SUSPENSION ASSEMBLY

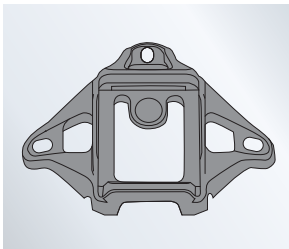

SHROUD

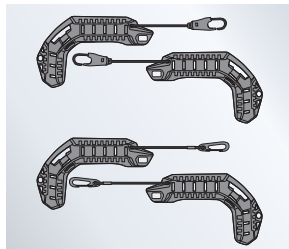

RAILS

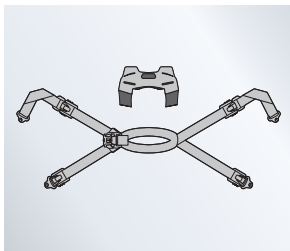

RETENTION SYSTEM



HARDWARE

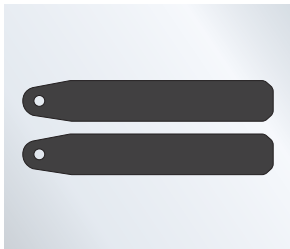
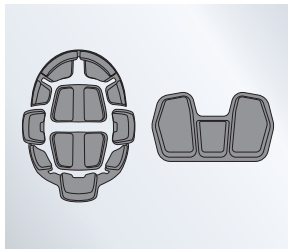
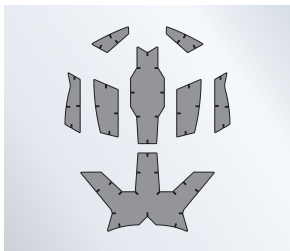
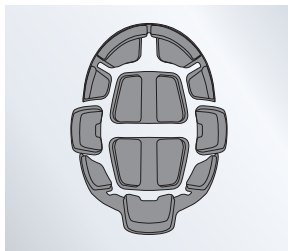

RAIL BUNGEEES

**ACCESSORY STRAPS****COMFORT PAD KIT****FITBAND KIT****EXTERNAL LOOP KIT****THICK COMFORT PADS**

ADDITIONAL ACCESSORIES

(Ordered Separately)

THE IMAGES USED IN THIS GUIDE ARE FOR REFERENCE ONLY AND MAY NOT REFLECT THE EXACT CONFIGURATION OF THE PRODUCT

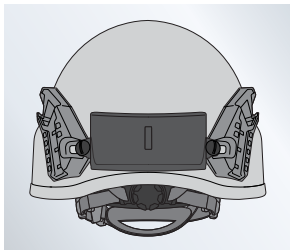

COUNTERWEIGHT

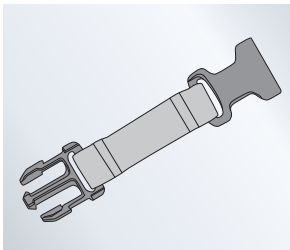

CBRN EXTENDER

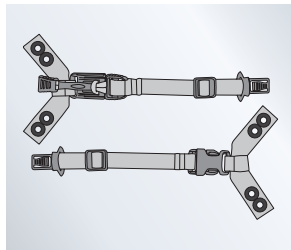

O2 STRAP EXTENDER

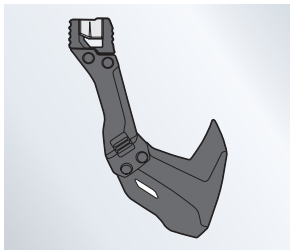

BUMP MANDIBLE

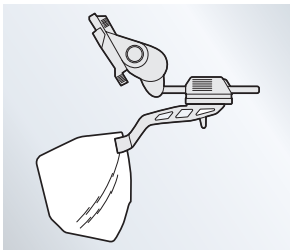

NVG ARM VISOR

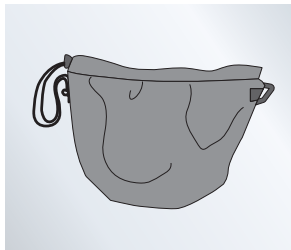

HELMET BAGS

CARE & SUPPORT

ONE-TIME EVENTS

If a severe impact damages the helmet resulting in dented or flattened areas, the helmet performance might be reduced. The helmet system should be replaced.

HELMET COVER CAN BE WORN TO MINIMIZE WEAR AND TEAR ON THE HELMET SHELL LOOP AND PAINT.

RECOMMENDED MAINTENANCE: ALL USERS

1. Clean the helmet with a mild soap and water
2. Check that the retention system bolts are tight
3. Clean the Loop to remove dust and dirt by using air pressure
4. Visually check the shroud and rails for signs of breakage
5. Visually check the fit band for signs of breakage
6. Check that the rear dial on the fit band works properly
7. Check that the retention system does not have any damage, that the buckle and strap tensioners open and close properly

IF ANY DEFECTS ARE DETECTED, THE DAMAGED COMPONENTS MUST BE REPLACED BEFORE USE.

HAVE QUESTIONS OR COMMENTS? CONTACT GALVION CUSTOMER SUPPORT

1-866-713-0406 | CUSTOMERCARE@GALVION.COM | GALVION.COM



©2024 GALVION INC. ALL RIGHTS RESERVED. GALVION™, BATLSKIN® AND BATLSKIN CAIMAN® ARE TRADEMARKS OF GALVION INC. OR ONE OF ITS AFFILIATES.
5-0008-0057 GAL3224_0424 REV A